

Article number: 51030456000010

Description: Vibration damper GS-M2
100x50x2000-15, NR shore 57

Measures

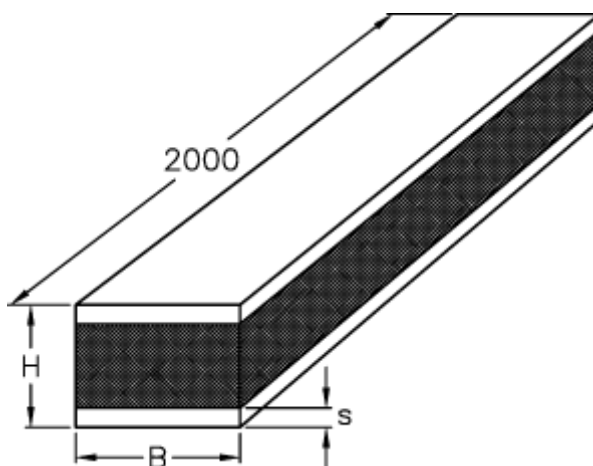

B = 100
H = 50
S = 15